

INDOOR

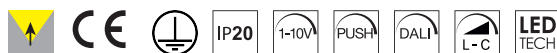

PARETE INCASSO / WALL BUIL-IN

## WALL



**Ferro**  
**Fascio di luce verso l'alto**  
**Driver: incluso**

Iron  
 Light beam: upward-projected  
 Driver: included

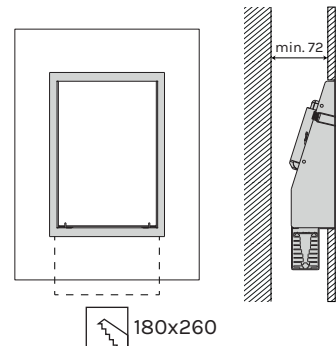

	<b>W 3000K</b>	<b>N 4000K</b>
<b>Potenza/ Power</b>	1x 14W	1x 14W
<b>Lumen</b>	1x 2015 lm	1x 2055 lm
<b>CRI</b>	80	80
<b>Alimentazione/ Supply</b>	220-240Vac	220-240Vac

Articolo Item	Temperatura Temperature	Finitura Finish
------------------	----------------------------	--------------------

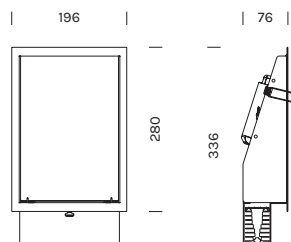

<b>7085</b>	<b>W</b> <b>N</b>	<b>-BI</b>
-------------	----------------------	------------

	<b>W 3000K</b>	<b>N 4000K</b>
<b>Potenza/ Power</b>	1x 14W	1x 14W
<b>Lumen</b>	1x 2015 lm	1x 2055 lm
<b>CRI</b>	80	80
<b>Alimentazione/ Supply</b>	220-240Vac	220-240Vac

Articolo Item	Temperatura Temperature	Finitura Finish	Dimmer
------------------	----------------------------	--------------------	--------

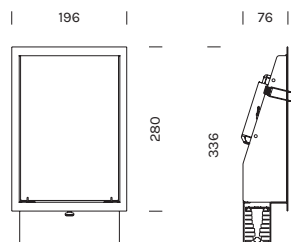

<b>7086</b>	<b>W</b> <b>N</b>	<b>-BI</b>	Dimmer 1-10V   PUSH
-------------	----------------------	------------	------------------------

Il codice prodotto si compone mettendo uno dopo l'altro, da sinistra a destra, i dati nelle colonne gialle, es: 1111M12-AA  
 The product code is created by putting in sequence the data under the yellow columns from left to right, e.g:1111M12-AA

<b>7087</b>	<b>W 3000K</b>	<b>N 4000K</b>
<b>Potenza/ Power</b>	1x 14W	1x 14W
<b>Lumen</b>	1x 2015 lm	1x 2055 lm
<b>CRI</b>	80	80
<b>Alimentazione/ Supply</b>	220-240Vac	220-240Vac

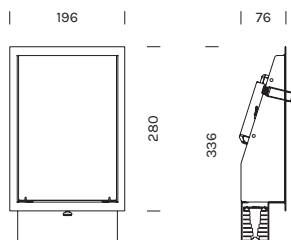

Articolo Item	Temperatura Temperature	Finitura Finish	Dimmer Dimmer
<b>7087</b>	<b>W N</b>	<b>-BI</b> 	L-C

<b>7088</b>	<b>W 3000K</b>	<b>N 4000K</b>
<b>Potenza/ Power</b>	1x 14W	1x 14W
<b>Lumen</b>	1x 2015 lm	1x 2055 lm
<b>CRI</b>	80	80
<b>Alimentazione/ Supply</b>	220-240Vac	220-240Vac

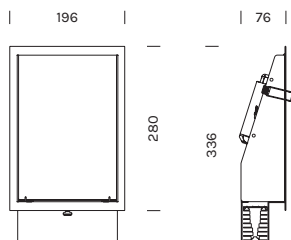

Articolo Item	Temperatura Temperature	Finitura Finish	Dimmer Dimmer
<b>7088</b>	<b>W N</b>	<b>-BI</b> 	DALI   PUSH

Il codice prodotto si compone mettendo uno dopo l'altro, da sinistra a destra, i dati nelle colonne gialle, es: 1111M12-AA  
 The product code is created by putting in sequence the data under the yellow columns from left to right, e.g:1111M12-AA

## Controcassa / Outercasing

Controcassa per muratura  
Outercasing for wall installation

Articolo  
Item

**CN01**

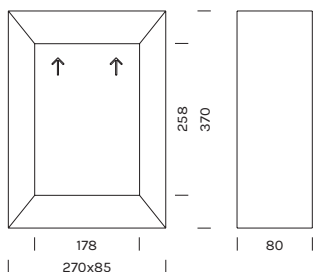

## Accessori / Accessories

Convertitore Taglio di Fase in  
interruttore Push (solo per 7087)  
Converter Phase Cut to Push Switch (for  
7087 only)

Articolo  
Item

**1A0177**

Potenza Power	IP	Dimensioni Dimensions	N° art. alimentabili N° of items powerable	Dimmer
100W MAX	IP20	32x50x18	1-6	PUSH